



PRODUCT
INFORMATION

3141
TWO RAIL TROLLEY
40 TON CAPACITY

DWG. NO:

3141A-1826

DATE: 01.07.00

REVISION: 0

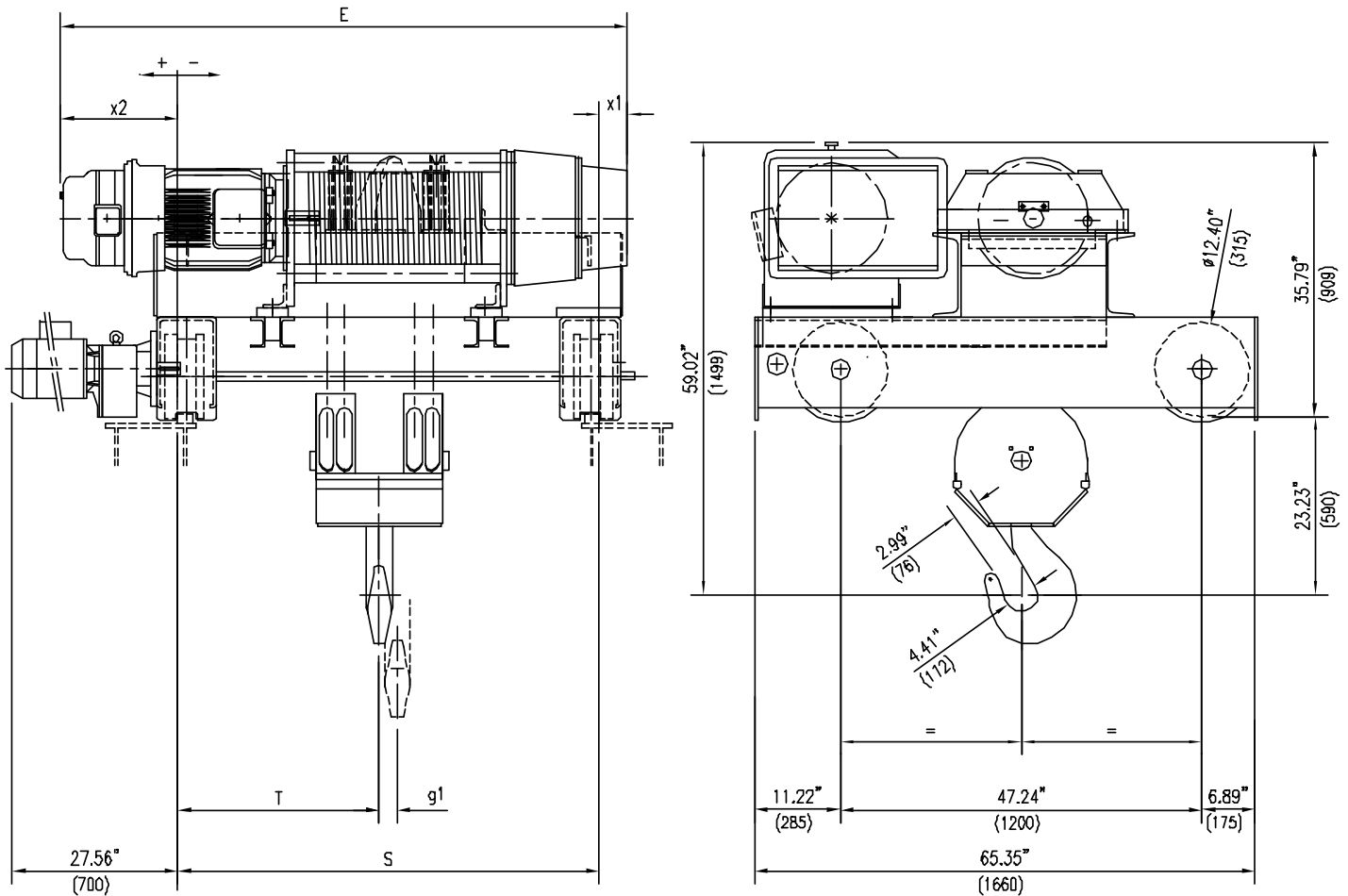

MUNCK RESERVES THE RIGHT TO MAKE CHANGE WITHOUT NOTICE.

HOIST TECHNICAL DATA

CAPACITY:	40 TONS (80000 LBS)	HOIST CLASS:	HMI H4	HOIST MOTOR:	26.8/8.4 HP, 1800/600 RPM, TEFC, S3 - 40%, CLASS "F" INSULATION
HOIST SPEED:	9 / 3 F.P.M { OPT. SPEEDS AVAILABLE }	POWER SUPPLY:	460V-3PH-60HZ		
TROLLEY SPEED:	84 / 19 F.P.M { OPT. SPEEDS AVAILABLE }	HOIST MOTOR:	6275-67	TROLLEY MOTOR:	3.2/.9 HP, 3600/900 RPM, TEFC, S3 - 60%, CLASS "F" INSULATION
		TROLLEY MOTOR:	9100-1785R08G		

DIMENSIONAL INFORMATION

HOIST TYPE	HEIGHT OF LIFT		S INCHES (mm)	T INCHES (mm)	E INCHES (mm)	g1 INCHES (mm)	x1 INCHES (mm)	x2 INCHES (mm)	WEIGHT LBS (KG)
	METERS	FEET							
3141A-1826	3.9	12'-9"	55.11 (1400)	26.38 (670)	74.17 (1884)	2.36 (60)	6.30 (160)	12.76 (324)	4180 (1900)
3141A-2826	6.0	19'-8"	55.11 (1400)	25.75 (654)	84.25 (2140)	3.66 (93)	16.54 (420)	12.60 (320)	4290 (1950)
3141A-3826	9.6	31'-6"	82.68 (2100)	38.43 (976)	101.93 (2589)	5.83 (148)	17.32 (440)	1.93 (49)	4840 (2200)
3141A-4826	-	-	-	-	-	-	-	-	-
3141A-5826	12.5	41'-0"	110.24 (2800)	51.30 (1303)	116.10 (2949)	7.64 (194)	16.93 (430)	-11.06 (-281)	5214 (2370)